

# Sanitary partition wall type EF-3H

Suspended construction made of sandwich elements with solid grade laminate surface

**schäfer**<sup>®</sup>  
Trennwandsysteme



Stylish and elegant partitioning.



BEFORE WE  
EXPECT TRUST FROM  
OUR CUSTOMERS,  
WE PROVIDE EVIDENCE  
*that's us!*

## ENVIRONMENT & SUSTAINABILITY

*that's us!*

Sustainable management and careful use of resources are a matter of course for us and part of our corporate philosophy. This basic idea is consistently integrated and lived in our work processes. We are proud to be the first certified manufacturer of partition systems and lockers in Germany to operate according to the FSC™ and PEFC guidelines.

### PEFC - registered

We pay attention to a sustainable supply chain in which our products are procured under ecological, economic and socially just aspects.

### FSC™ - certified

As the first certified manufacturer in the area of partition systems and lockers in Germany, we make an active contribution to the protection of our earth with this future-oriented procurement method.

We supply almost our entire range from sustainable wood in accordance with the specifications of the FSC™.



*On request  
the products are  
available with  
FSC™ certification*

## TÜV NORD GS TESTED SAFETY

*that's us!*

Tested and certified by TÜV NORD these products meet the requirements of the Product Safety Act ProdSG § 21 Registration No. 44 329 14148801.



## MADE IN GERMANY

*that's us!*

Our products are manufactured for you at the company site in Horhausen, Rhineland-Palatinate. This is the only way we can guarantee the high quality standards we set for our products.



## PREQUALIFIED

*that's us!*

We are registered in the list of prequalified construction companies with the number 010.049740, proving that we are qualified for the products and services we offer.



## INNOVATIVE & DESIGN-ORIENTED

*that's us!*

With our design-oriented and innovative products, we convince not only our customers, but also national and international committees.



reddot winner 2021







## Suspended, foot-free WC partition wall for the highest demands.

The Schäfer EF-3H WC cubicle impresses with its extremely high ease of cleaning and its ingenious design. The suspended construction lends a special lightness to the sanitary room. The WC partition walls seem to float above the floor. Supporting feet become largely superfluous. This WC cubicle is a visual highlight in any sanitary room. An extremely positive side effect of the foot-free design is the simplified and more efficient cleaning. The robust and completely waterproof sandwich elements make the toilet facility look like new even after years of use.



#### Interesting facts about EF-3H

##### **WC partition walls made of 36 mm thick sand-white elements with HPL surface**

- Up to a length of 4.5 meters supports are not needed if the brick walls are stable
- Internally torsion-resistant aluminium frame
- Flush front
- Durable construction
- Effective and durable finger pinch protection
- High-quality anodised aluminium hardware system
- Completely waterproof. Ideal for wet areas
- Efficient cleaning due to floor clearance
- Wide range of decors and colours
- Individual colour combinations are a design element and orientation aid at the same time
- Customised motif prints are possible
- WC partition wall is made to measure





(1)

(1)

**Privacy screens made of glass**

- Wall hanging construction
- Made of enamelled safety glass (ESG-H)
- Mounting by means of discreet aluminium or stainless steel brackets
- Hygienic and easy to clean
- Waterproof
- Easy floor cleaning due to the construction
- Colour selection according to RAL colour chart
- Motif prints optionally possible
- Privacy screens will be produced acc. to the building site dimension

(2)

**Privacy screens type EF-3**

- Wall-hanging privacy screens
- Made of 36 mm thick sandwich elements with HPL surface
- Easy to clean and maintain
- Installed with durable aluminium holders
- Reinigungsfreundlich und pflegeleicht
- Wide range of colours available
- Motif prints are optionally available
- Privacy screens will be produced acc. to the building site dimension



(2)

(3)

**Privacy screens type SV30**

- Wall-mounted privacy screens
- Made of 30 mm thick chipboard
- ABS strips and panels in the same colour
- Installed with durable aluminium holders
- Wall-mounted structures without bottom support feet are particularly hygienic, since floor cleaning can then be faster and more efficient
- Wide range of colours available
- Motif prints are optionally available
- Privacy screens will be produced acc. to the building site dimension



(3)

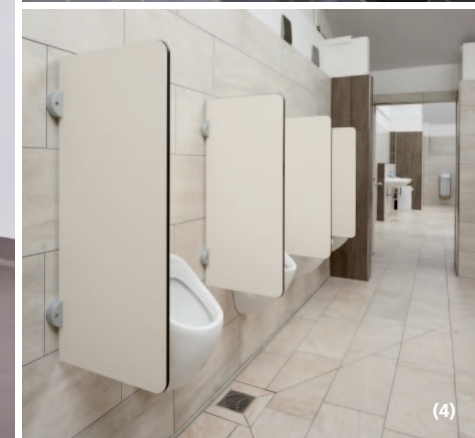

(4)

(4)

**Privacy screens type VK13**

- Wall-mounted privacy screens
- Made of 13 mm solid grade laminate
- Revolving edge is always black
- Installed with durable aluminium holders
- Waterproof
- Wall-mounted structures without bottom support feet are particularly hygienic, since floor cleaning can then be faster and more efficient
- Wide range of colours available
- Motif prints are optionally available
- Privacy screens will be produced acc. to the building site dimension

## Features type EF-3H

### Supports:

The EF-3H unit largely manages without support feet. If necessary, support feet are designed as follows:



- Stainless steel supports, height-adjustable



- Aluminium supports, height-adjustable, price neutral

### Hinges:



- Anodised aluminium rising hinge with high-performance polymer
- Treads guarantee absolute freedom from maintenance and a silence, self-closing of the door
- Door hinges are generally used for door openings over 110°



- Optional available: hinges located in the door rebate which ensure a complete flush front wall
- Optional available: internal tube door closer for a self-closing function of the door

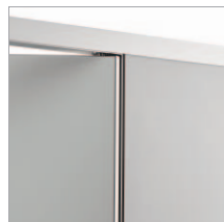

- Self-closing doors through an integrated tenon hinge for a max. door opening of 110°

## Variation of accessories type EF-3H

### Hardware:



Aluminium  
door handle  
Schäfer AL7050



Stainless steel  
door handle  
Schäfer ES6050



Nylon  
one hand door knob



Stainless steel  
one hand door knob



Aluminium  
one hand door knob  
INSAFE



Aluminium  
push handle SLIDESAFE

[To the handrail configuration online tool >](#)

[To the push handle SLIDESAFE >](#)

[To the sanitary accessories >](#)

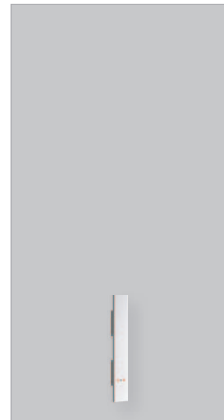

Aluminium handrail  
55 x 500 mm  
Schäfer ALGS1

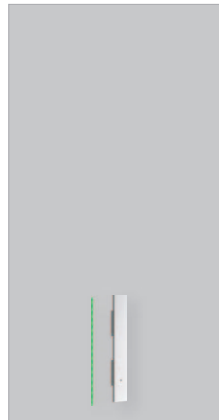

Aluminium handrail  
with LED strip  
55 x 500 mm  
Schäfer ALGS1 LED

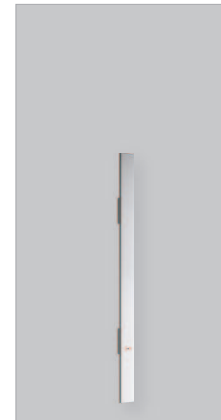

Aluminium handrail  
55 x 1.150 mm  
Schäfer ALGS2

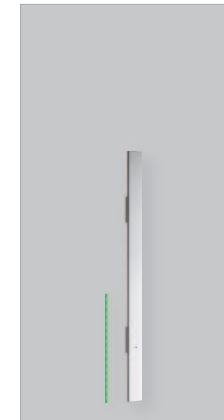

Aluminium handrail  
with LED strip  
55 x 1.150 mm  
Schäfer ALGS2 LED



Aluminium handrail,  
adapted to the door  
length, always until the  
top edge of the door  
Schäfer ALGSV

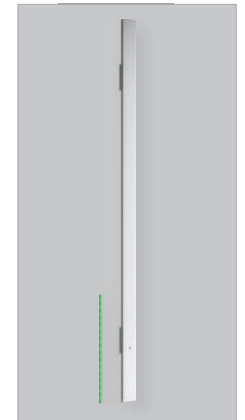

Aluminium handrail with  
LED strip, adapted to the  
door length, always until  
the top edge of the door  
Schäfer ALGSV LED

### Buffer and hooks:



Aluminium buffer  
Schäfer AL7015



Stainless steel buffer  
Schäfer ES6015



Nylon buffer  
Schäfer N8015



Aluminium hook  
Schäfer AL7011



Stainless steel hook  
Schäfer ES6011



Nylon hook  
Schäfer N8010

## Colours type EF-3H

### Panels:



2001  
Weiß

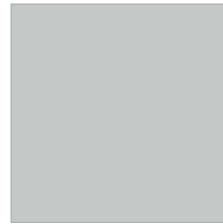

2002  
Silbergraugrau

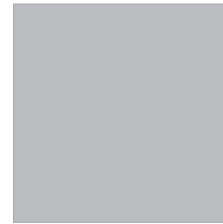

2010  
Aluminiumgrau



2004  
Anthrazit



2006  
Limonengrün



2007  
Atlantik



2008  
Pflaume

### Profiles:

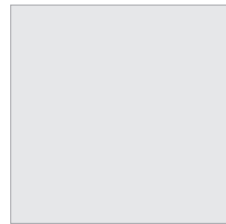

E6/EV1  
Eloxiert

Special colours for panels, wall-connection profiles in all RAL colours and special accessories are available upon request. Ask us!

There may be a difference between printed colours and real colours.



## Technical design of cubicle system type EF-3H

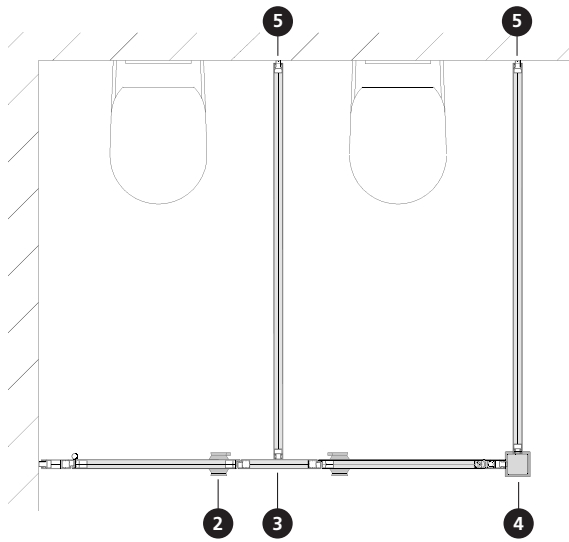

2 Cubicle front with one-hand door knob and 180° aluminium rising hinge

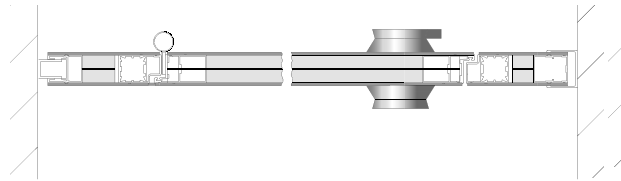

2 Cubicle front with one-hand door knob and 110° pivot hinge with finger pinch protection

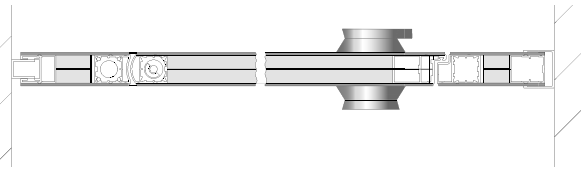

Front height section

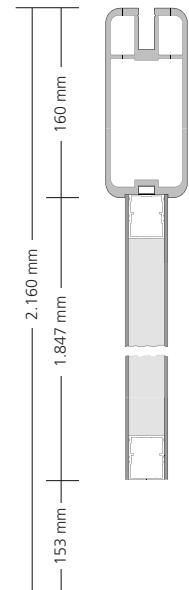

4 Corner connection

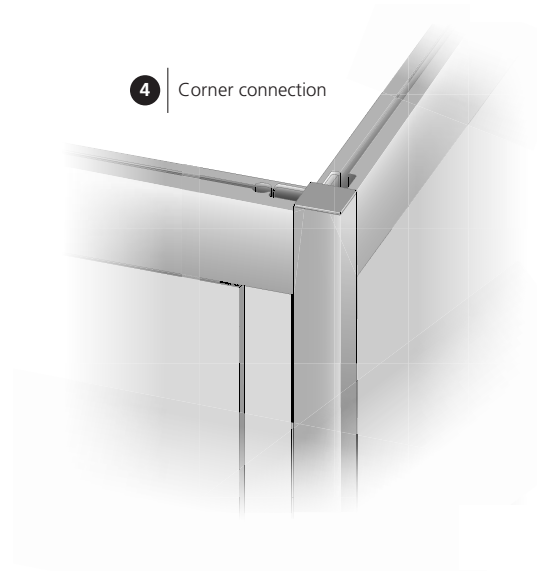

3 Front to partition wall connection

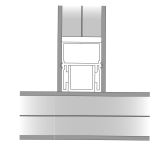

5 Wall connection shadow gap

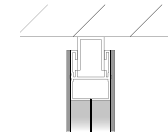

5 Wall connection embracing

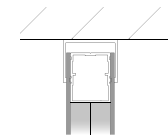

We reserve the right to make technical alterations.



reddot winner 2021



GERMAN  
INNOVATION  
AWARD '22  
WINNER

